



ESTOFADOS

Somos o que vivemos!



O seu ambiente e a atmosfera em  
torno de você co-criam o seu  
bem-estar.

2501



# 2501

Molas bonnel.  
Espuma hipersoft.  
Pés em madeira ou alumínio pintado.  
Braço auxiliar em madeira (opcional).

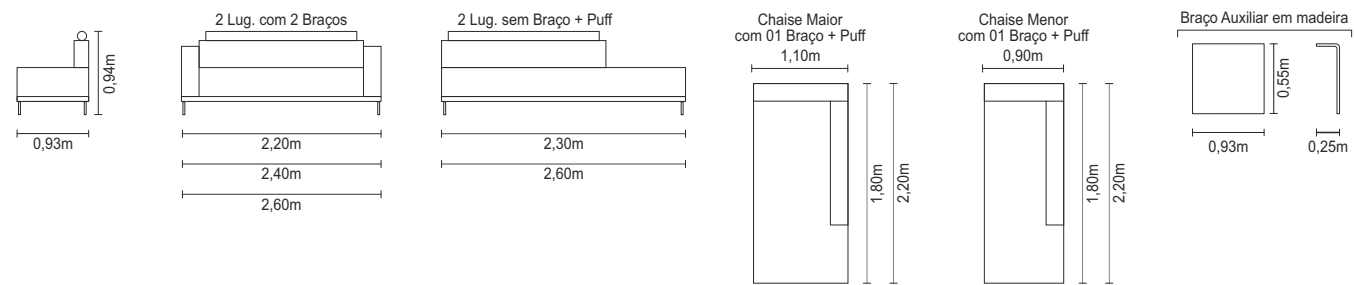

1007



# 1007

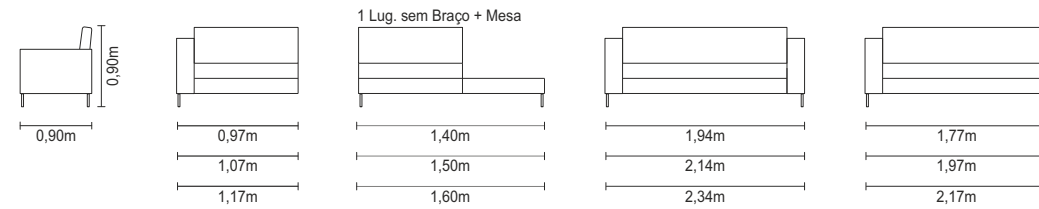

Espuma D28 Soft.  
Espuma hipersoft.  
Pés em madeira ou alumínio pintado.  
Mesa de apoio lateral em  
madeira (opcional).





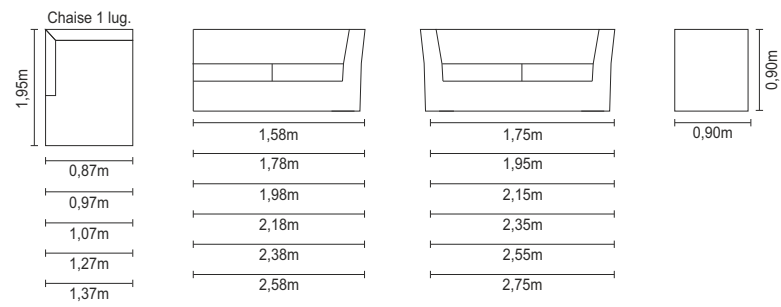

# 1124

Espuma D28 Soft.  
 Fibra siliconizada.  
 Capa removível.



# 1502

Molas ensacadas.  
Espuma D28 Soft e Hipersoft.  
Pés alumínio cromado.

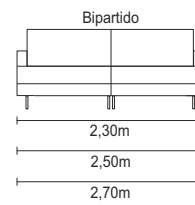
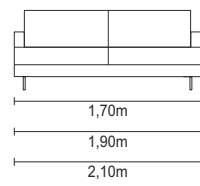
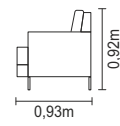

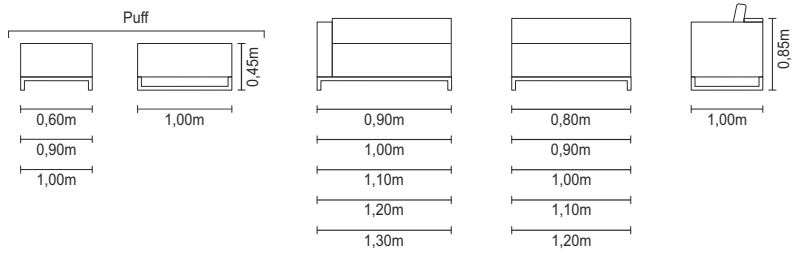

503

Molas bonnel.  
 Espuma D28 Soft.  
 Fibra siliconizada.  
 Requadro em madeira.  
 Matelassê em couro (opcional).



# 4004

Molas bonnel.  
Espuma D28 Soft.  
Fibra siliconizada.  
Pés em madeira ou alumínio pintado.

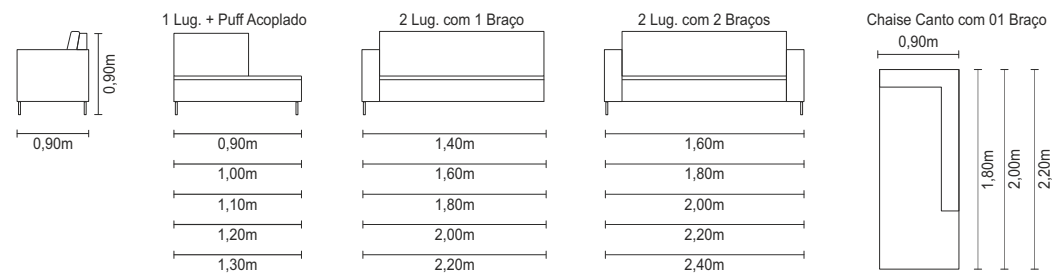

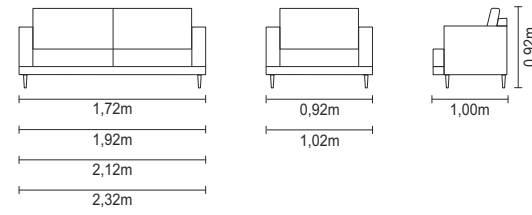

3 4 0 1

Espuma HR 35.  
Espuma Hipersoft.  
Pés em madeira.



1403

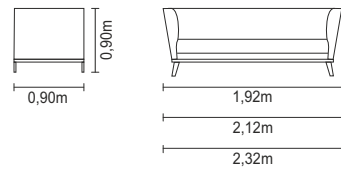

Molas bonnel.  
Espuma D28 Soft.  
Fibra siliconizada.  
Requadro em madeira.



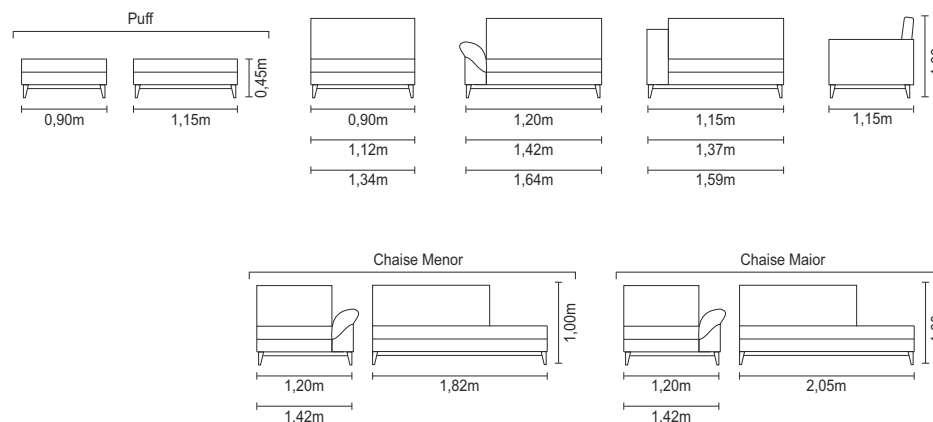

2 2 2 2

Pillow Top.  
Fibra Termo Bond.  
Requadro em madeira ou  
pés em alumínio.  
Encosto reclinável.



# 1070

Molas bonnel.  
Pés ou requadro em madeira.

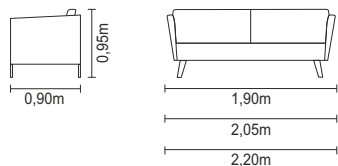

# 1061

Encosto e assento com  
almofadas soltas.  
Espuma D28 Soft.  
Capa removível.

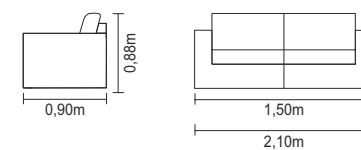



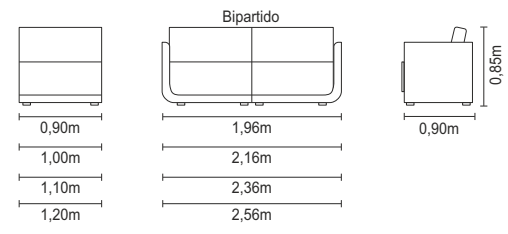

2303

Molas bonnel.



1 2 3 2

Molas bonnel.

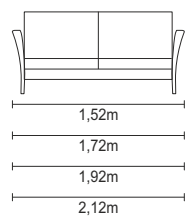
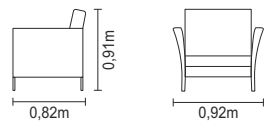

1 3 2 2

Molas bonnel.  
Requadro em madeira.

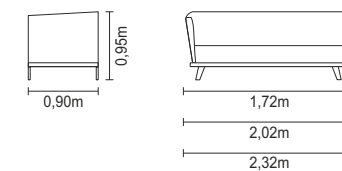



Chaise Canto com 01 Braço

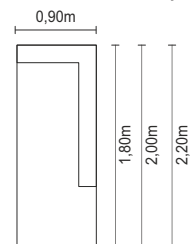

2 Lug. com 2 Braços

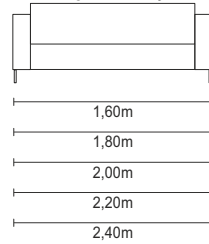

2 Lug. com 1 Braço

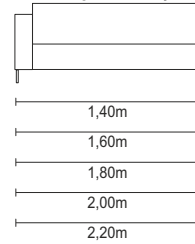

1 Lug. + Puff Acoplado

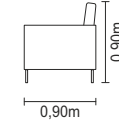
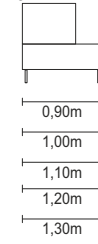

# 2 2 1 3

**Molas bonnel.**  
**Pés em madeira ou**  
**alumínio pintado.**  
 (cores na página 62)



# 2015

Molas bonnel.  
Requadro em madeira.

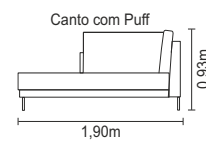
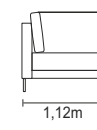
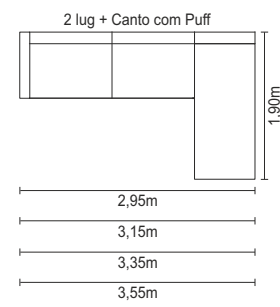
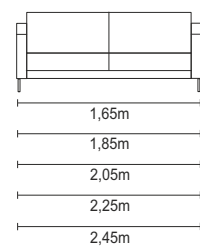
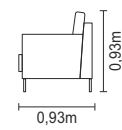

# 2051



Molas bonnel.  
Requadro em madeira.

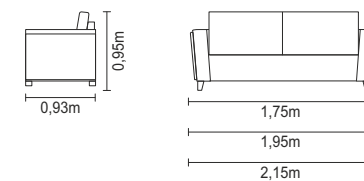

Opcional:  
Couro natural

# 8000

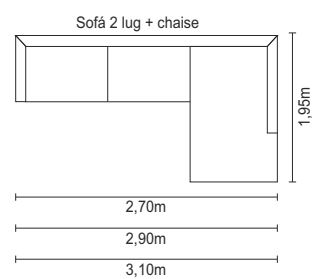
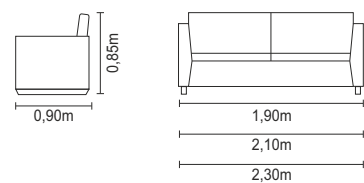

# 7001

Molas ensacadas.  
Requadro em madeira.

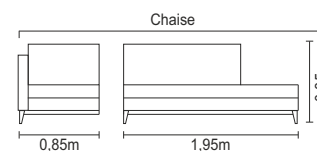
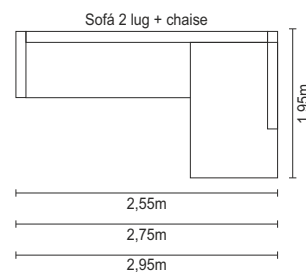
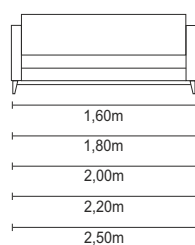
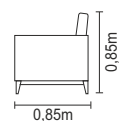

3 3 2 0



Molas bonnel.  
Espuma D28 Soft.  
Pillow Top: 13cm.  
Pés em alumínio ou madeira.

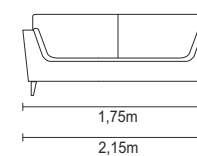
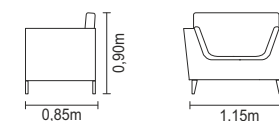

4 0 4 0

Espuma D28 Soft.

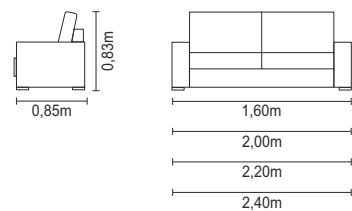

Largura braço: 0,20m



# 7100

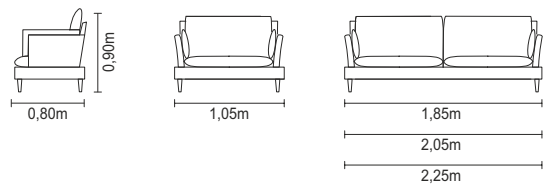

Assentos e encosto com  
almofadas soltas.



Opcional:  
Couro natural





# 2141

Molas bonnel.  
Pés em alumínio ou madeira.  
Assento fixo e encosto com  
almofadas soltas.

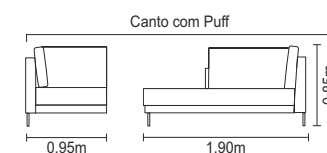
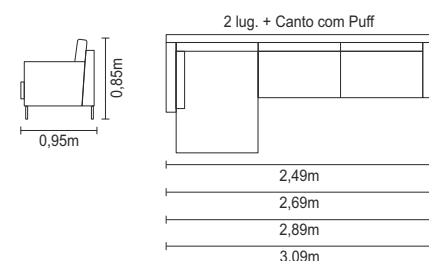
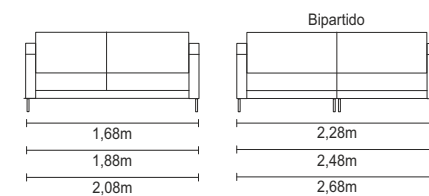

# 1313

Molas ensacadas.

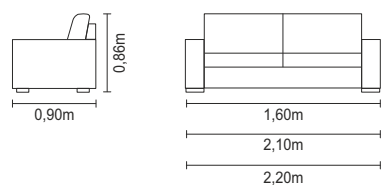

# 2420

Molas ensacadas + Nozag

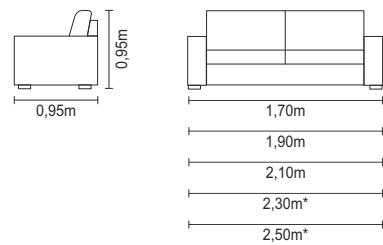

\*Braços desmontáveis



# 5111



Molas bonnel.  
*handmade* (feito à mão)

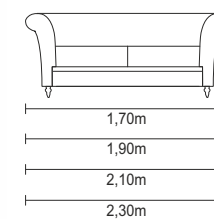
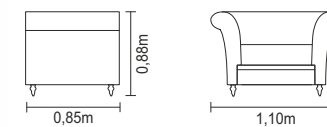

# 2105

Opcional:  
Couro natural

Molas ensacadas.  
Capitonê feito à mão.

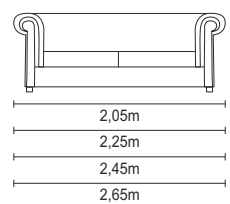
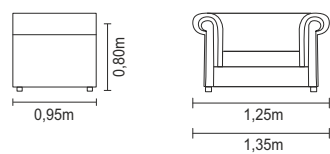

Opcional:  
Tachas

# 1511

Pés em madeira ou alumínio.

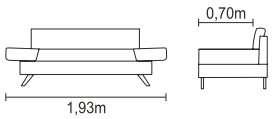
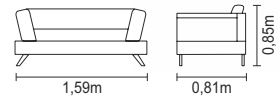

# 1016

Pés em madeira.

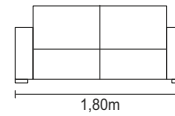
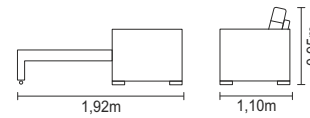

Obs.: Medida interna da cama: 1,92 x 1,40m



# 3122

Molas ensacadas.  
Espuma hipersoft.

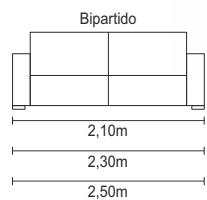
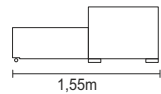
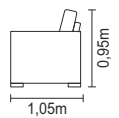

Obs.:  
Medidas interna da cama:  
1,80 x 1,35m  
2,00 x 1,35m  
2,20 x 1,35m



# 6101

Colchão com  
malha de matelassê

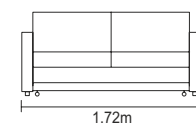
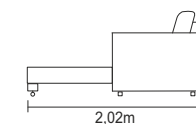
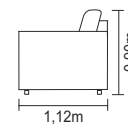

Obs.: Medida interna da cama: 1,90 x 1,40m



2123



2 1 2 3

Molas bonnel.  
Pillow Top em espuma HR 45.  
Fibra siliconizada.

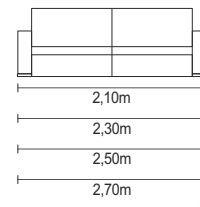
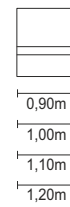
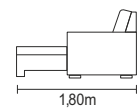
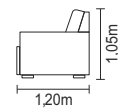

1430



1430

Molas ensacadas.  
Espuma Hipersoft.  
Matelassê em fibra siliconizada.

Cama aberta:  
1,80 / 2,00 / 2,20 / 2,40 x 1,35m

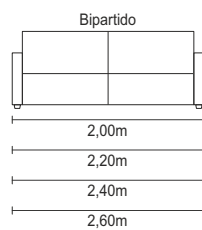
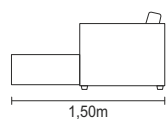
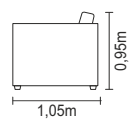

Usado como  
sofá cama



2024



2024

Molas bonnel.  
Pillow Top em espuma D28 Soft.  
Fibra siliconizada.

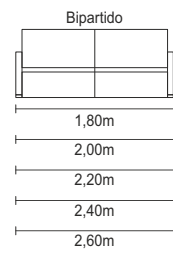
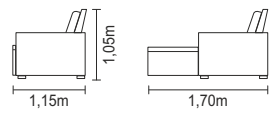

1241



# 1241

Molas bonnel.  
Pillow Top em espuma D28 Soft.  
Espuma Hipersoft.  
Fibra siliconizada.

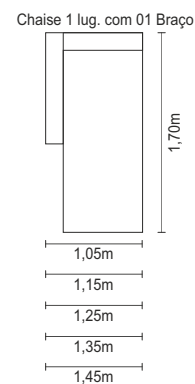
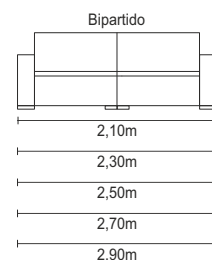
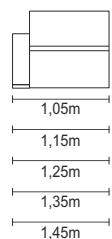
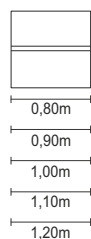
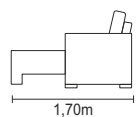
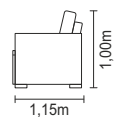

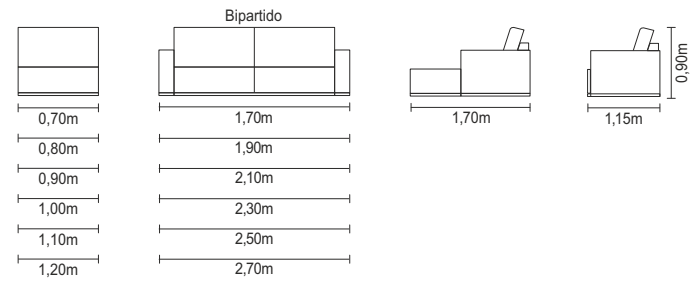

3 1 1 3

Molas bonnel.  
Requadro em madeira.



# 1412

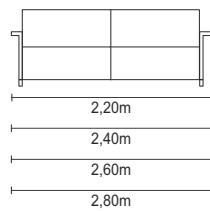
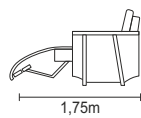
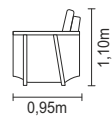

Reclíneo e extensão  
simultânea motorizada.  
Pillow Top hipersoft.  
Braço de madeira.



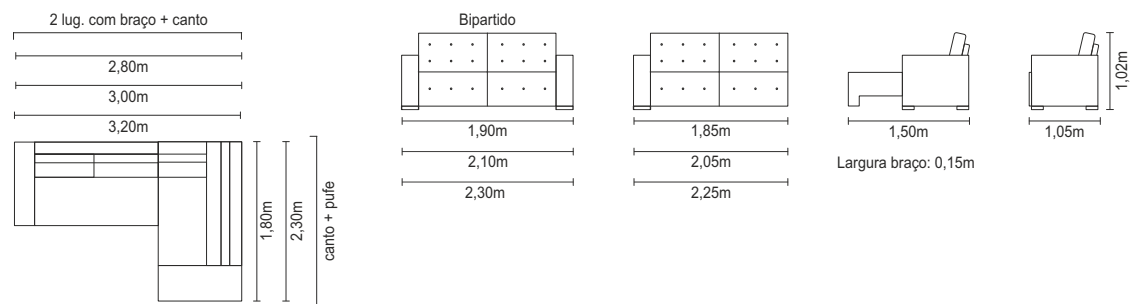

1700

Molas ensacadas.  
Reclinável.



# 1421

Molas bonnel.  
Encosto espuma hipersoft.  
Reclinável.  
Requadro em madeira.

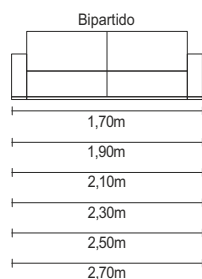
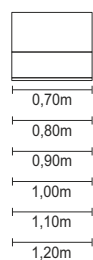
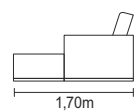
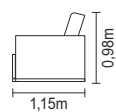



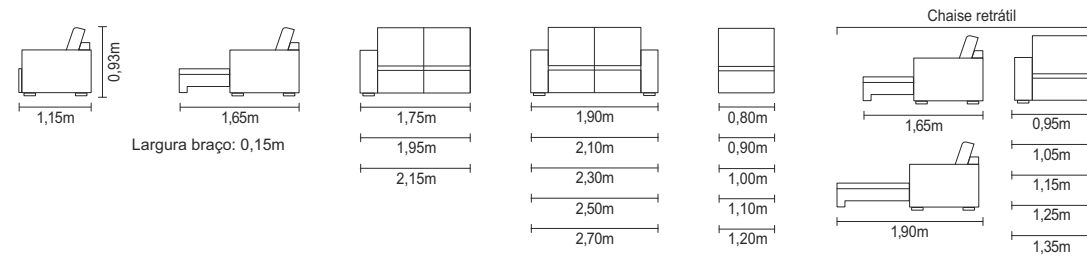

5300

Molas ensacadas.



Opcional:  
Abertura motorizada.



# 3 3 1 1

Molas ensacadas.  
Pillow Top em espuma D28 Soft.  
Fibra siliconizada.

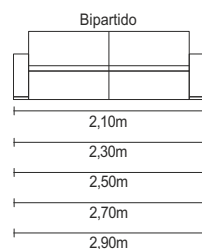
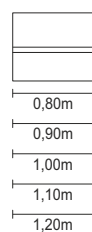
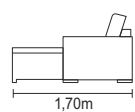
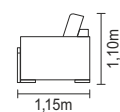

# 4310

Molas bonnel.  
Reclinável.

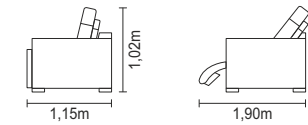

Obs.: Peseira fechada: 1,60m

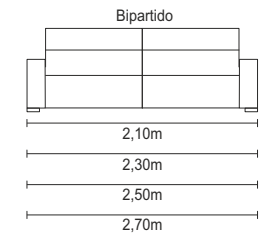

Opcional: Braço Baú  
(Acessórios, ver página 63)



# 5120

Molas bonnel.  
Pillow Top: 8cm / 14cm / 18cm  
Reclinável.

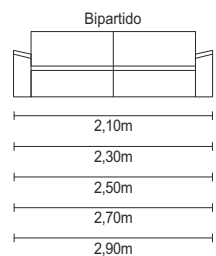
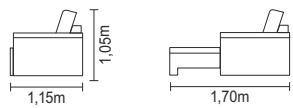

Pillow Top 8cm

# 2060

Molas ensacadas.  
Assento, encosto e braços com  
costura em matelassê.  
Reclinável.

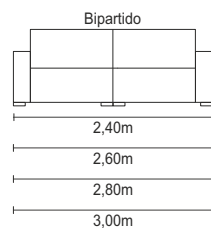
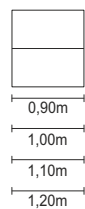
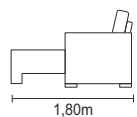
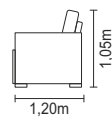

Opcional:  
Massageador.

Opcional:  
Abertura motorizada.



# 5210

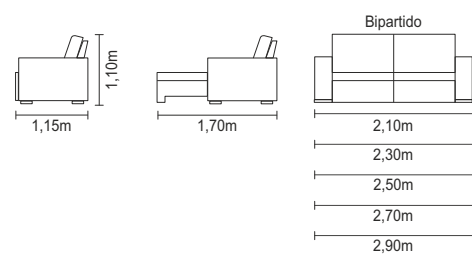

# 5210 A

Braço Almofadado

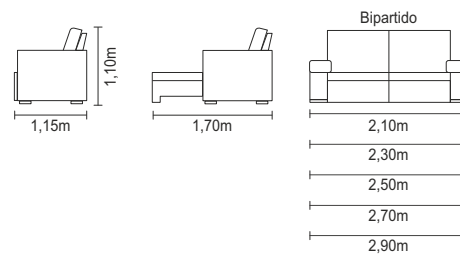

# 5210 B

Braço Reto

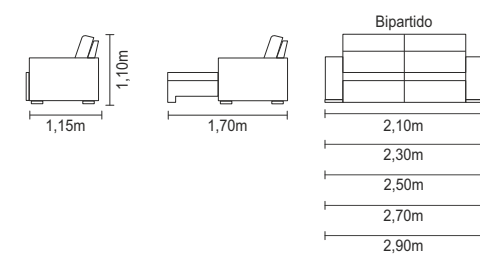

Molas bonnel.  
Pillow Top: 14cm  
Reclinável.



# 2150

Molas bonel.  
Pillow Top.  
Reclinável.

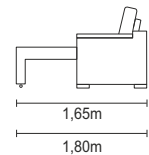
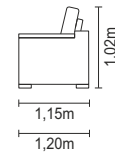

Largura braço: 0,35m

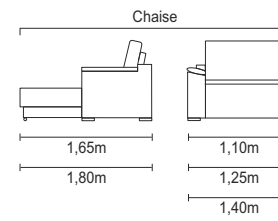
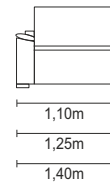
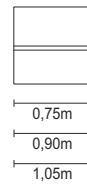

# 2600

Abertura motorizada.



Reclínio e elevação motorizada.  
Pillow Top espuma D28 Soft  
e Termo Bond.

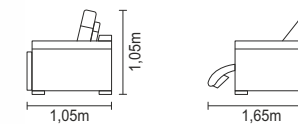

Largura braço: 0,25m

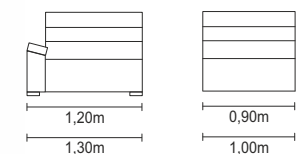

# 1115

Pillow Top: 20cm  
Molas ensacadas.  
Reclinável (7 estágios).

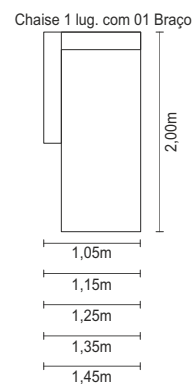
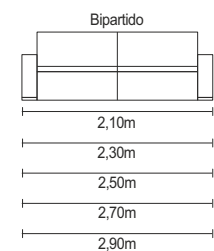
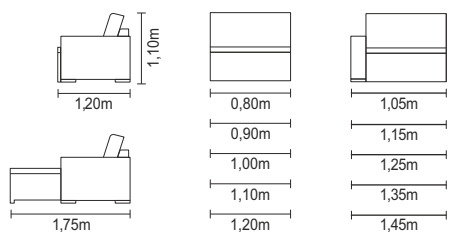

# 2051

Requadro em madeira.

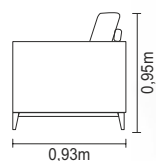
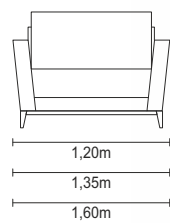

# 2042

Estrutura em aço carbono.  
Cordame em algodão ou couro natural.

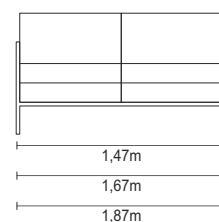
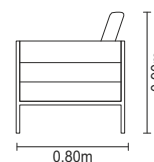
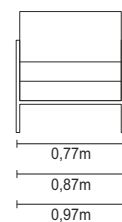

# 1142

Requadro em madeira.

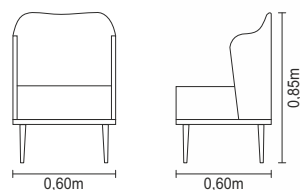

# 440

Pés em madeira.  
Base giratória em madeira.  
Base fixa em aço carbono.

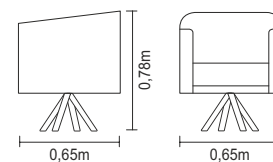

Largura braço: 7,5cm





# 1151

Pés em madeira ou alumínio pintado.  
(cores na página 36)

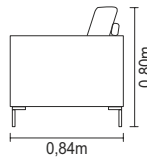
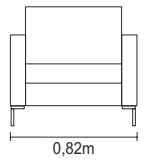

Opcional:  
Couro natural

# 4013

Base giratória em madeira.

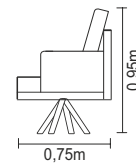
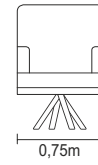

# 4112

Pés em madeira.

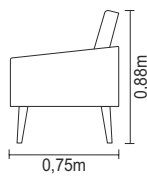
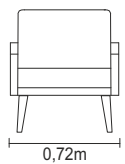

# 7100

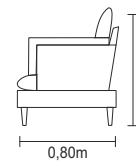
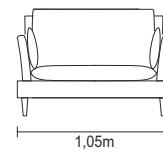

# 1025

Base giratória em madeira.

Base giro e balanço em alumínio.

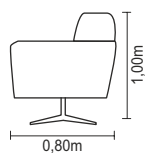

# 1205

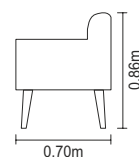
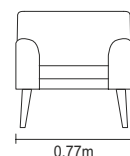

# 3014

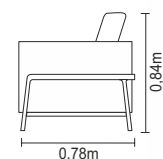
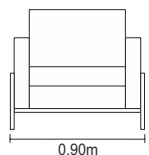

# 4121

Base giratória em madeira.  
Pés em madeira ou alumínio.

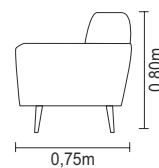
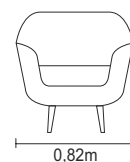

4400

Pés em madeira ou alumínio.

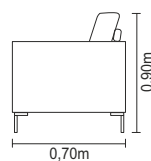
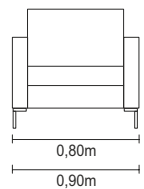

2033

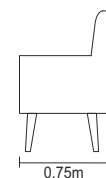
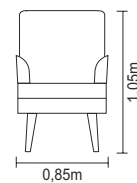

6002

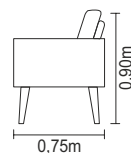

1601

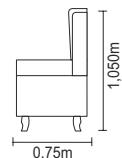
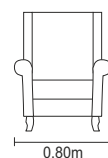

4211

Base giratória e balanço.  
Pés em madeira.

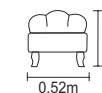
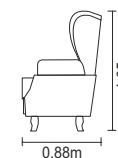
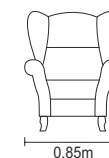

# 6011

Reclinável manual ou motorizada  
 Opcional: Massageador  
 Lift Chair (sistema de auxílio à  
 saída c/ elevação motorizada)

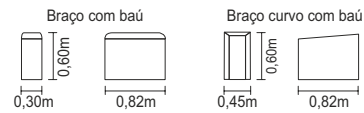
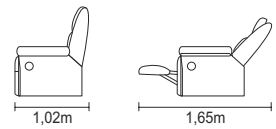
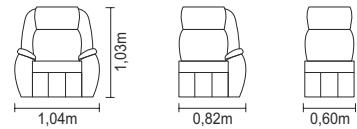

OPCIONAL:  
Lift Chair

# 7010

Reclinável manual ou motorizada.

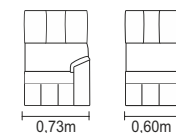
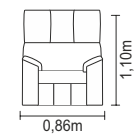
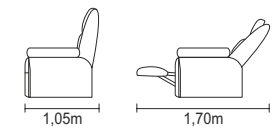

# 5201

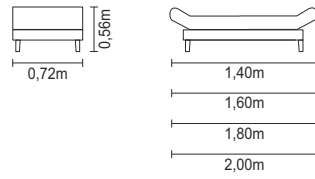

Base em Fibra Natural (junco) ou tecido.



OPCIONAL:  
Fibra natural (junco)

# 1133

Requadro em madeira.

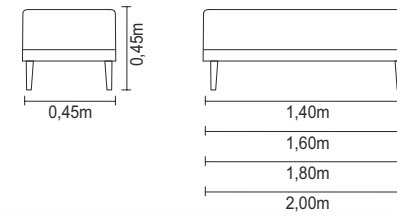

# 4301

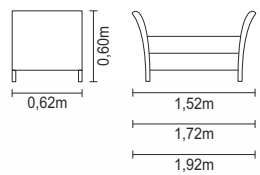

# 4103

Pés em alumínio ou madeira.

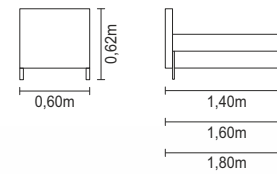

Opcional: Baú

# 1331

Chaise long.  
Pés em madeira ou aço carbono.

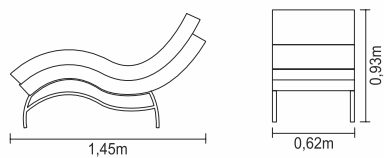

# 2411

Captonê com ou sem  
cristais Swarovski.

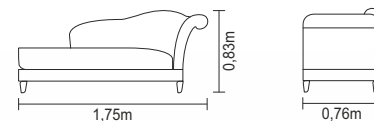

# 3041

Chaise long.

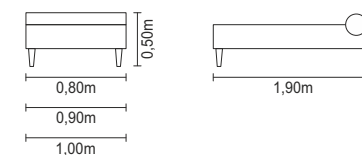

1 2 2 3



Chaise long.

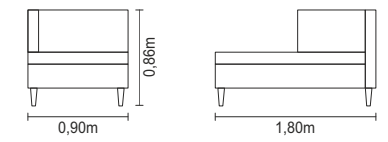

1 2 1 4

Chaise long.

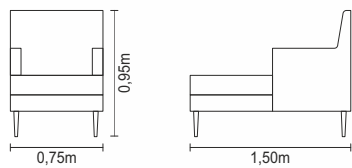

2 5 1 0

Chaise long.

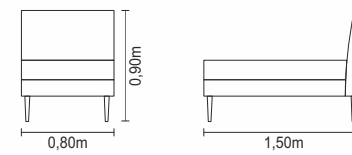

# 1034

Chaise long.  
Pillow Top em espuma HR 45.

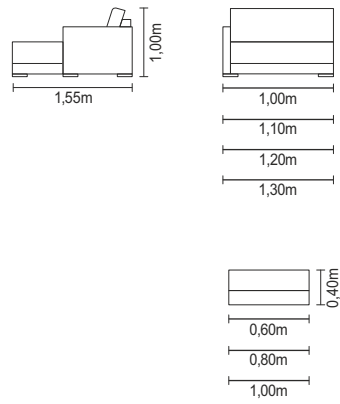

# 2114

Chaise long.  
Espuma HR 45.

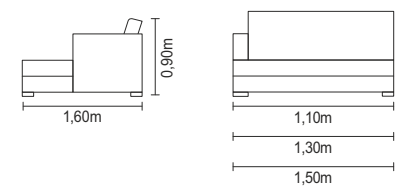



# 3500

Requadro em madeira ou alumínio pintado (opcional).

\*Painel sob medida (m<sup>2</sup>)

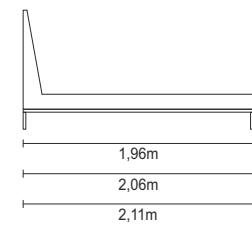
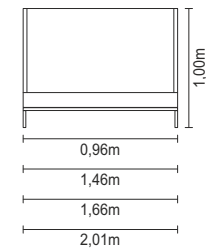

# 1106

\*Painel sob medida (m<sup>2</sup>)

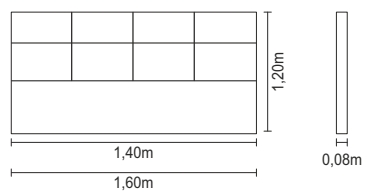

# 1250

\*Painel sob medida (m<sup>2</sup>)

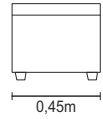
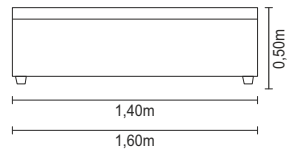
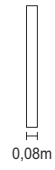
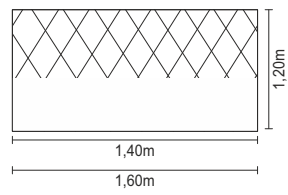

# 2006

\*Painel sob medida (m<sup>2</sup>)

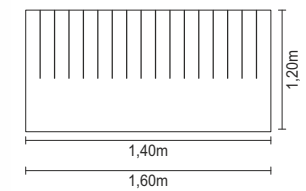

2 3 2 1

\*Painel sob medida (m<sup>2</sup>)

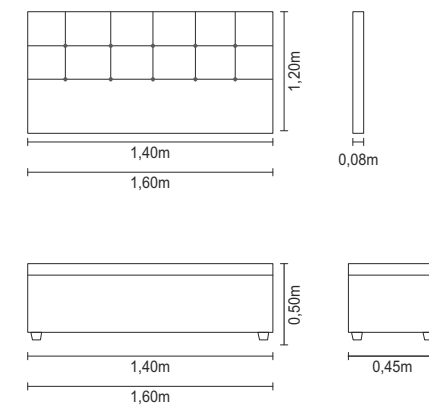

2 3 3 0

\*Painel sob medida (m<sup>2</sup>)

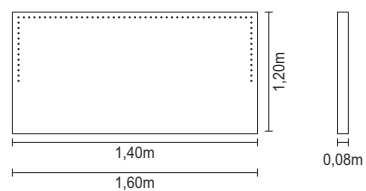

3 2 1 2

\*Painel sob medida (m<sup>2</sup>)

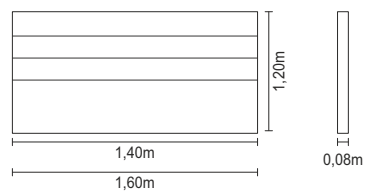

4 2 0 2

\*Painel sob medida (m<sup>2</sup>)

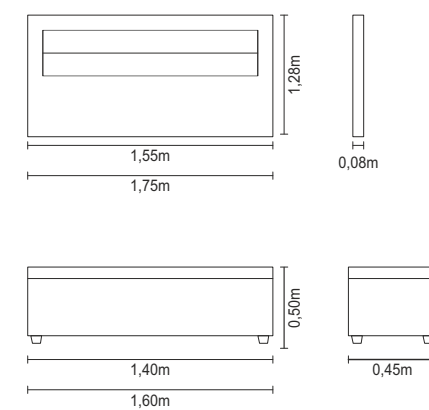



6 2 0 0

\*Painel sob medida (m<sup>2</sup>)

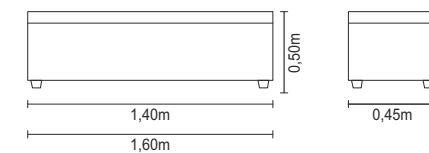
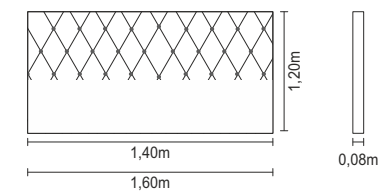

1 6 1 0

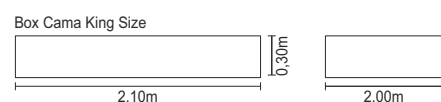
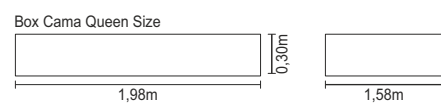
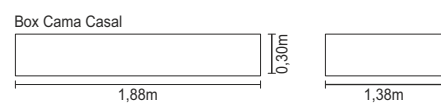
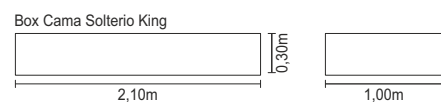
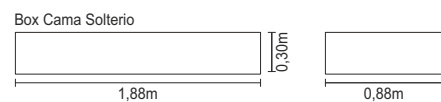

1520

Diâm.: 0,45 - Alt: 0,45 - Prof.: 0,45m

Diâm.: 0,60 - Alt: 0,45 - Prof.: 0,60m

Diâm.: 0,75 - Alt: 0,45 - Prof.: 0,75m



2402

Diâm.: 0,45 - Alt: 0,45 - Prof.: 0,45m

Diâm.: 0,60 - Alt: 0,45 - Prof.: 0,60m

Diâm.: 0,75 - Alt: 0,45 - Prof.: 0,75m



## MADEIRA

Cores:



Amêndoa



Imbuia

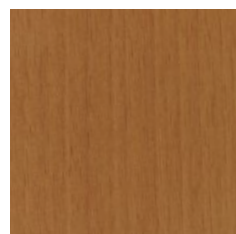

Mel

## BASES



Giratória  
Madeira



Aranha  
Alumínio

## PÉS EM ALUMÍNIO



Master



Central

Cores:



Grafite

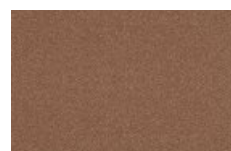

Cobre

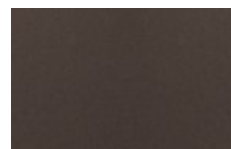

Chocolate



Preto

## MOLAS



Bonnel



Enscadas

# ACESSÓRIOS

- Mini USB  
Branco / Preto



- Mini Totem Automático



- Abertura Motorizada Touch



- Massageador / Audio Vibe



- Braço Baú



## MESA LATERAL DE APOIO

Cores:

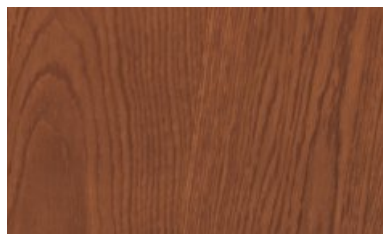

Freijó



Marmorizado

## BRAÇO CURVO EM MADEIRA



### Esquema de Montagem Baioneta

1° Passo: Posicione o módulo dos assentos e os braços do estofado com as costas para baixo.

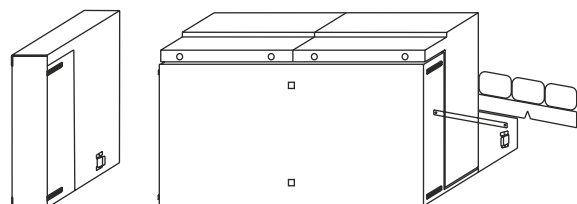

2° Passo: Encaixe os braços no módulo dos assentos de modo que os engates fiquem parcialmente encaixados.

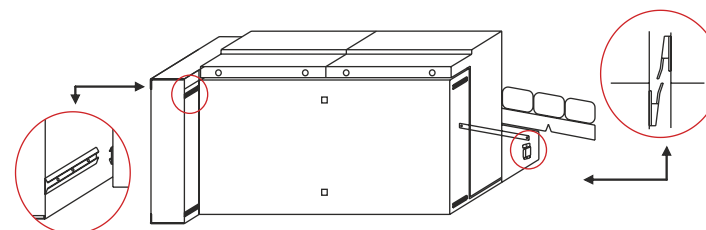

3° Passo: Coloque o sofá na sua posição correta, que automaticamente os engates se encaixarão de maneira que seu estofado esteja pronto para o uso.

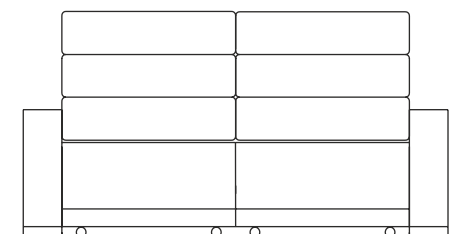

# Descrição técnica:

## **ESTRUTURA:**

Madeira de eucalipto, aplainado, bitolado, proveniente de madeira de reflorestamento. Resistência natural ao cupim.

## **ALMOFADAS:**

Almofadas soltas dos encostos são confeccionadas em fibra siliconizada, revestidas com falso tecido, tipo travesseiro, facilitando o manuseio.

## **ESPUMA DOS ASSENTOS:**

D26, D28. Soft: D28, D30, super soft D33 e visco elástica.

## **PÉS:**

Imbuia, mel, amêndoa, cromados ou alumínio.

## **BASES DAS POLTRONAS:**

Alumínio, aço carbono cromado pintado em epóxi e aço inox. Catracas de encosto e braços, 04 estágios.

## **EMBALAGEM:**

Plástico liso, papelão ondulado e malha. Conservação dos produtos e prazo de garantia: Ver manual que acompanha o estofado.

## **ESPUMA DOS BRAÇOS:**

D30, D28, D26, D23.

## **GRAMPOS:**

Duplos de aço galvanizado.

## **MOLAS:**

Ensacadas (cobertas com camada de espuma) ou bonnel (trançadas com percintas elásticas) que aumentam o conforto e resistência do estofado.

## **ESPUMAS:**

As espumas são específicas para cada modelo conforme descrição no catálogo.

## **ESPUMA DOS ENCOSTOS:**

D23, D20 soft e hiper soft.

## **PERCINTAS:**

Elásticas importadas.

Obs: Nossos estofados podem ser produzidos em medidas especiais, para tanto é necessário consultar a fábrica e solicitar orçamento e prazo de entrega.







[www.kfestofados.com.br](http://www.kfestofados.com.br)

Rua São Paulo, 1104 | Bairro Borgo | Bento Gonçalves | RS

Fone (54) 3454.3687 | [kfestofados@kfestofados.com.br](mailto:kfestofados@kfestofados.com.br)